

OPEN AIR MERCHANDISERS VERTICAL · 28" DEEP · SHORT



EOMV-48-B-28-S

EOMV Series



Refrigeration System

- Bottom mounted, self-contained and fully detachable Blizzard R290 condensing unit uses environmentally friendly, EPA-compliant R290 refrigerant with zero (0) Ozone Depletion Potential (ODP) and three (3) Global Warming Potential (GWP). Blizzard R290 is easily replaceable and requires no on-site brazing.
- Front air intake and rear air discharge design allows side by side installation.
- Electronically commutated (ECM) evaporator fan motors achieve rapid cooling with less energy consumption.
- High performance, auto-reverse condenser fan motor supports compressor ventilation and condenser coil cleaning.
- Large capacity, corrosion-resistant condenser and evaporator coils.
- Self-maintaining, energy-efficient condensate drain pan requires no external drains or electric heaters.
- Pre-wired and ready to plug, 115V/60Hz/1Ph, NEMA 5-20P.

Cabinet Construction

- Black modern exterior has moisture-resistant panels and field replaceable tempered glass.
- Heavy-duty stainless steel interior has perforated back wall for efficient air flow. Includes floor drains for ease of cleaning.
- Front stainless steel bumper belt protects against shopping cart impact.
- Galvanized steel top, bottom and rear.
- 2.5" thick high-density polyurethane insulation.
- Integrated retractable night curtain saves energy and provides security.
- 5" swivel casters with locks on front set. Leg stabilizers included.

Lighting

- Shielded LED bar lighting under shelves and canopy provide bright, high color illumination at lower heat output. On/off switch saves energy

Shelving

- Adjustable by height and angle. Position it flat or slanted downward at 10°.
- Heavy duty stainless steel shelves include price tag moldings.

Temperature Control

- Factory preset temperature of 35°F maintains a combined average product temperature of 40°F or less.
- Audible overheat protection alarm for compressor and condenser coil.

Recommended Operating Conditions

- Conforms to NSF standard 7 TYPE II designed to operate in an air-conditioned environment where temperature and humidity do not exceed 80°F and 55% respectively.
- Must not be installed near ventilation systems, fans or exterior doors or windows that will disrupt the air curtain.
- Must not be installed in direct sunlight.
- In built-in applications, a distance of 6" is required on the front, back and top exterior for ventilation purposes



Type	Capacity Cu. Ft.	Shelves	NEMA Plug	Refrigerant	HP	Power V-Hz-Ph	Amps	Crated Weight	Exterior Dimensions		
									L	D	H*
REF	12.2	3	NEMA 5-20P	R-290	1/2 x 2	115-60-1	10	662 lbs	48"	28.38"	60.13"

(†)Based on evaporating temperature of 23°F (-5°C) & condensing temperature of 131°F (55°C). (P) Product capacity is calculated based on standard industry figures. (*) Reference plan view for clarification on caster/unit height. If dimensions and capacity are critical, please contact Everest Refrigeration. Blizzard R290 replacement is at the sole discretion of Everest Refrigeration. Specifications subject to change without notice.

OPEN AIR MERCHANDISERS

VERTICAL · 28" DEEP · SHORT



EOMV-48-B-28-S

EOMV Series

DIMENSIONAL DATA

External Dims.	L	48 in.
	D	28.38 in.
	H*	60.13 in.
Crated Weight		662 lbs.
Doors/Drawers/Lids		-
Max Weight Support		-

STORAGE DATA

Net Capacity Cu. Ft. †	12.2
Shelves	3
Barrels	-
20 oz. Bottles	-
12 oz. Bottles	-
12 oz. Cans	-
8" Mugs	-
# of Pans (Top)	-
# of Pans (Drawer)	-
Dividers	-
Trays	-

ELECTRICAL DATA

Voltage	115-60-1
Full Load Amperage	10A
Feed Wires w/ Ground	3
Cord Length	9ft
NEMA Plug Type	Ⓜ NEMA 5-20P

REFRIGERATION DATA

Compressor	Bottom
Refrigerant	R-290
Compressor HP	1/2 x 2
BTU/HR †	12

KEY

D	Door	R	Refrigerator
L	Lid	REF	Refrigerator
H	Half Door	F	Freezer
FD	Full Door	FRZ	Freezer
SD	Solid Door	DUAL	REF/FRZ Combo
GD	Glass Door	DR	Drawer

	Elevation	Right	Plan	3D	Back

PLAN VIEW

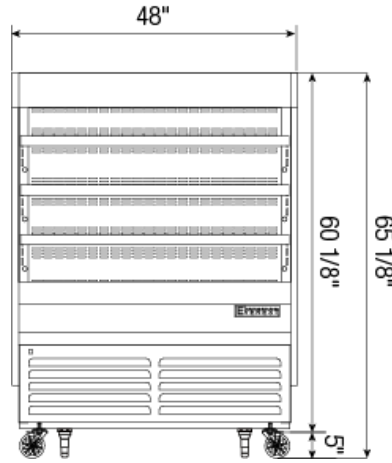

FRONT

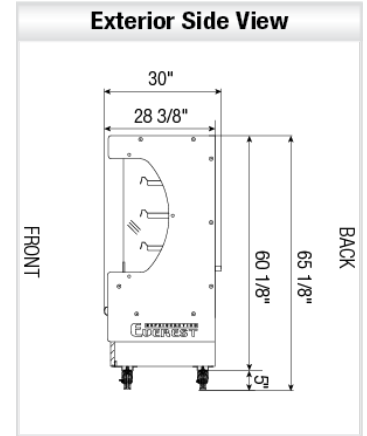

SIDE

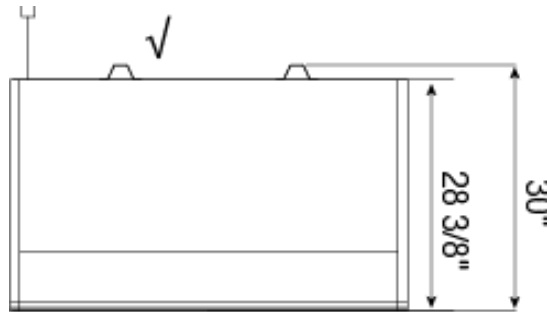

TOP

ACCESSORIES & OPTIONS

(†)Based on evaporating temperature of 23°F (-5°C) & condensing temperature of 131°F (55°C). (‡) Product capacity is calculated based on standard industry figures. (*) Reference plan view for clarification on caster/unit height. If dimensions and capacity are critical, please contact Everest Refrigeration. Blizzard R290 replacement is at the sole discretion of Everest Refrigeration. Specifications subject to change without notice.